

# INSPECTION | JOYSTICK

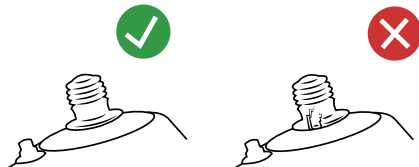

5 min

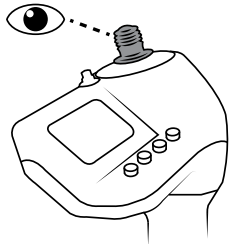
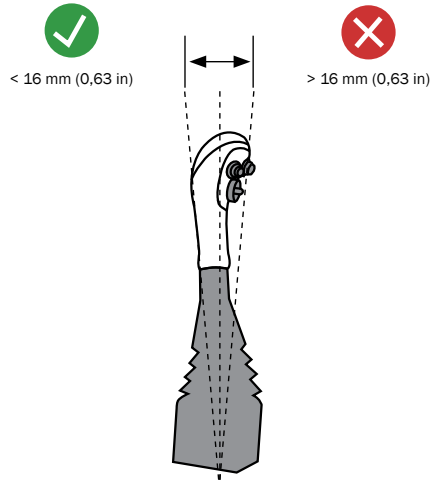
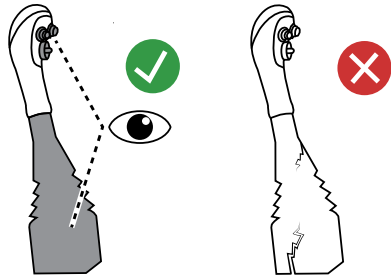
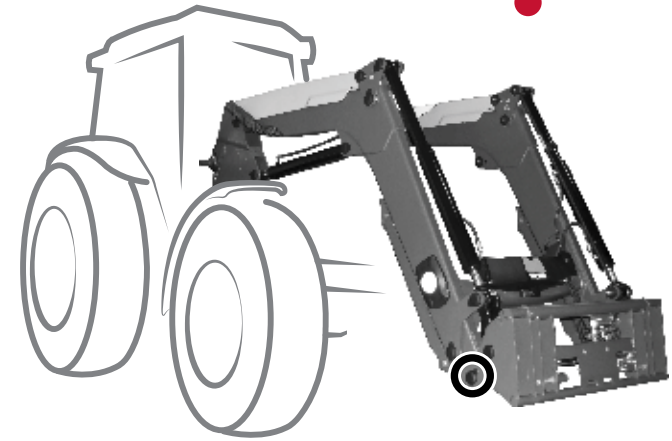
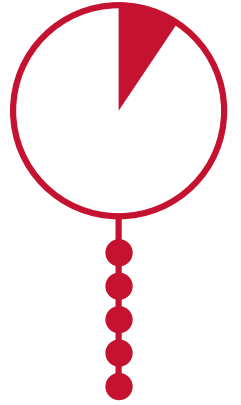

# 5 MINUTE FRONT LOADER INSPECTION

## INSPECTION PINS

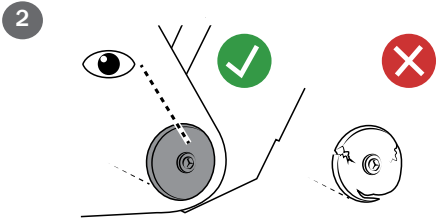
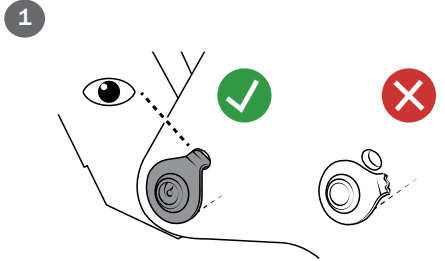
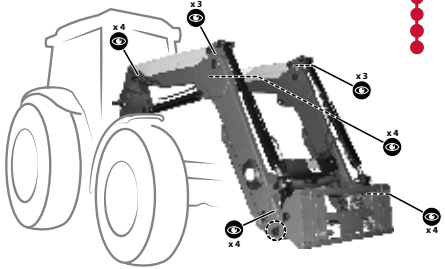
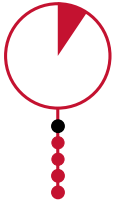

## INSPECTION BUSHING

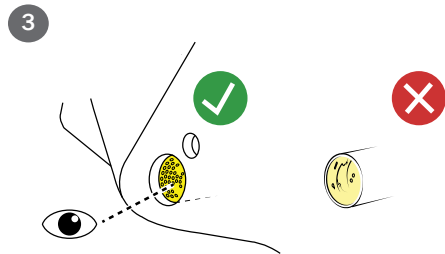
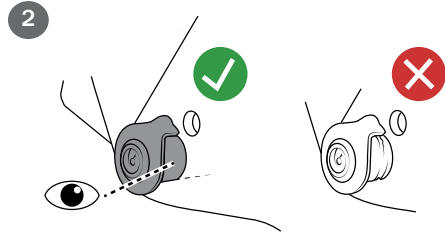
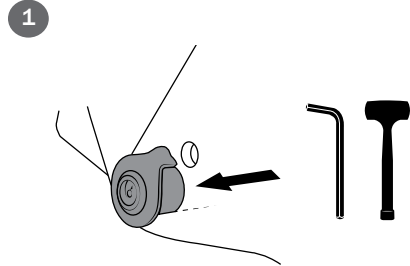
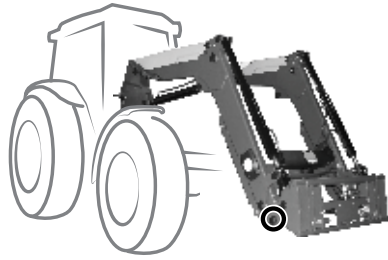

## INSPECTION HYDRAULICS

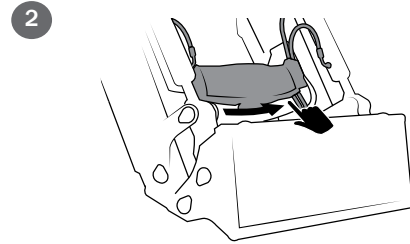
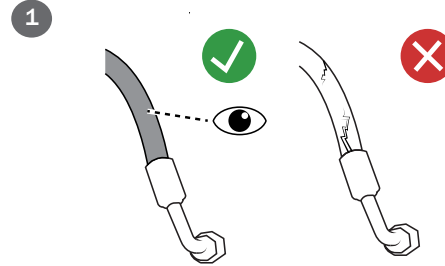
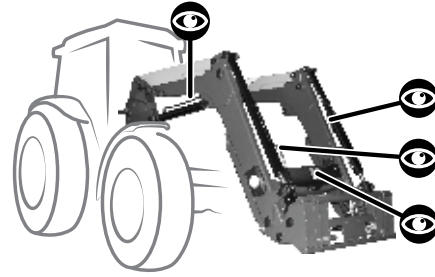

## INSPECTION LOAD SUSPENSION

