

AMS

SAFETY & COMFORT

EN

AUDIO AND VIDEO SOLUTIONS



CATALOGUE 2020



A CUSTOMER SERVICE TEAM AT YOUR DISPOSAL

Your satisfaction is our priority. Our sales team is at your disposal to advise and support you in your projects.

You can place your orders through the internet, by email, fax or phone. Orders are usually processed within 24 to 48 hours. There is no minimum order.

For further information, you can contact the Sales Department at : +33 (0)3 27 94 44 44 or send an email to contact@ams-diffusion.com



OUR TECHNICAL TEAM WILL WORK WITH YOU

Our technical support staff supports you at every step. Do you have a question, a technical inquiry or do you need any advice? Our entire team is at your disposal to meet your needs. In case of a product return to our customer service, we will send you the product back within 8 days, repaired or replaced. To return the product for free, use the form on our website.

You can contact the technical service at +33 (0) 3 27 94 44 41 or by email at infotech@ams-diffusion.com.



A CONTROLLED PROCESS

We design and assemble the majority of our products in France. Thanks to our production team, we have a complete mastery of the process at each stage.

This mastery enables us to meet your needs and guarantee a perfect service level. In addition, our products are 100% controlled and tested in France according to the highest standards.

Quality control is our highest priority and the reason behind our ISO 9001-2015 certification.



AMS COMMITS

This is why we are constantly working on reducing our carbon footprint, through the control of our power consumption and raw materials.

In this sense, we have been certified ISO 14001:2015 for our environmental management system.

SUMMARY

Our services

2



Audio solutions

- Shallow depth radios
- CD radios
- Accessories

3
5
6
8



Videos solutions

- Reversing camera kits
- Cameras
- Screens
- Adaptor cables
- Accessories

11
12
14
17
21
24



AMS displayer

Enhance and optimize your sales area

25



#1

AUDIO SOLUTIONS

RADIOS AND ACCESSORIES

AMS radios are robust, resistant to dust, shocks and vibrations for an optimum use in professional environments. Enjoy a multitude of functions (Bluetooth, DAB+, Back-up memory ...) for ideal comfort. As an option, a range of customised radios with branded logo is available (without any extra cost).

FM RADIO

Item code : ARAMSCT412



BLUETOOTH RADIO

Item code : ARAMSCT412_BT

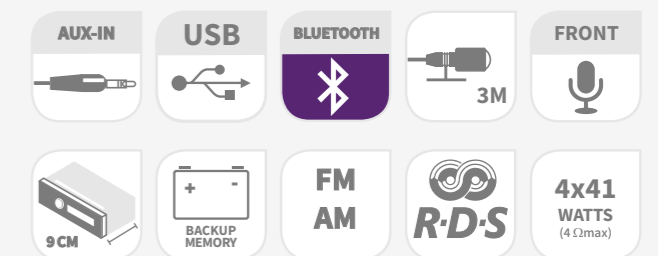

BLUETOOTH DAB+ RADIO

Item code : ARAMSCT412_DAB_BT

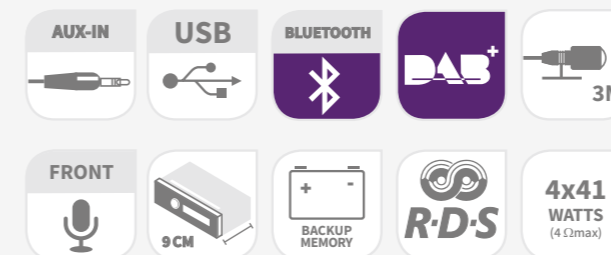

NEW

BLUETOOTH 24V RADIO

Item code : ARAMSCT424_BT

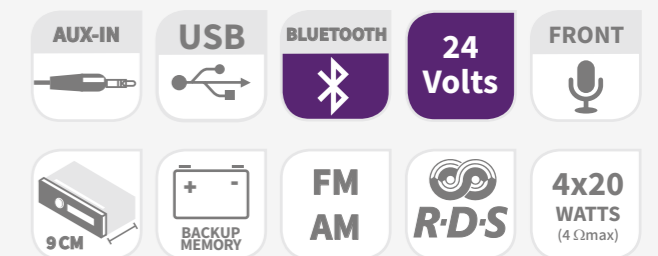

BLUETOOTH CD RADIO

Item code : ARAMSCB710_BT



Made for iPod iPhone iPad

DAB+ CD RADIO

Item code : ARAMSCB710_DAB_BT



Made for iPod iPhone iPad

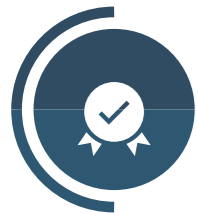

All our radios are guaranteed for 2 years



Vibration and dust resistant



Developed to fit the most demanding fields of application



Easy to use and efficient



	CT412	CT412 BT	CT412 DAB BT	CT424 BT	CB710 BT	CB710 DAB BT
Item code	ARAMSCT412	ARAMSCT412_BT	ARAMSCT412_DAB_BT	ARAMSCT424_BT	ARAMSCB710_BT	ARAMSCB710_DAB_BT
Depth	90mm	90mm	90mm	90mm	165mm	165mm
Voltage	12V	12V	12V	24V	12V	12V
Output power	4x10W	4x41W	4x41W	4x20W	4x45W	4x45W
RDS Tuner FM/ MW /LW	✓	✓	✓	✓	✓	✓
Multi Zone Tuner	✓	✓	✓	✓	✓	✓
DAB+	-	-	✓	-	-	✓
Preselection 18 FM, 12 AM,6 LW	✓	✓	✓	✓	✓	✓
DAB+ Preselection	-	-	18	-	-	6
RDS clock	✓	✓	✓	✓	✓	✓
Backup Memory EPROM	✓	✓	✓	✓	✓	✓
4 Band Equalizer (Pop, Classic, Rock, Jazz)	✓	✓	✓	✓	✓	✓
Facade lighting control		✓	✓	✓	✓	✓
Built-in alimentation	✓	✓	✓	✓	✓	✓
SD card	✓	-	-	-	✓	✓
LCD display	✓	✓	✓	✓		
Removable front panel	-	-	-	-	✓	✓
USB Front	✓	✓	✓	✓	✓	✓
Compatible format	WMA/MP3	WMA/MP3	WMA/MP3	WMA/MP3	WMA/MP3/AAC	WMA/MP3/AAC
Bluetooth	-	✓	✓	✓	✓	✓
CD reader	-	-	-	-	✓	✓
Compatible Ipod/ Iphone	-	-	-	-	✓	✓

LOUDSPEAKERS



Item code		
1	HP_100_BC	Loudspeakers 10 cm - 35 W
	HP_130_BC	Loudspeakers 13 cm - 50 W
2	HP_160_2V	2 ways loudspeakers 16 cm - 80 W
3	HP_BOX_2V	Two ways loudspeaker box - 60W
4	HP_9x15_2V	Dual cone loudspeakers - 40W

LOUDSPEAKER GRILLS



Item code		
1	HP_GR_100	Two 10 cm loudspeaker grills
	HP_GR_130	Two 13 cm loudspeaker grills
2	HP_GR_100-R	Two round 10 cm loudspeaker grills
3	HP_ENT_130_15	2 Loudspeaker spacer frames diameter 13 cm, thickness 1.5 cm

MICROPHONE / ACCESSORIES



Item code		
1	MIC_BT	Bluetooth microphone suitable for Bluetooth radios (jack 3,5 mono)
2	EL_C351500	150 cm Jack 3.5 mm male/male Cable
3	EL_JACK_MIC	Jack microphone adaptor 2,5/3,5mm

HARNESSES



Item code		
1	FID600_634	ISO - Loudspeaker and power supply
2	FID412_HP	Loudspeaker ISO harness - suitable for CT412
3	FID630	Extension ISO harness - suitable for CT412

GOOSENECK MICROPHONE

Item code : MIC_BT_XL



Microphone, ideal in loud environments, delivered with a 4m jack cable 3,5mm mono

ANTENNES



Item code		
1	ANT_30_TS	Flexible antenna AM/FM - Round base - Extension cable 230 cm
2	ANT_35_TR	Rigid antenna AM/FM - Square base - Extension cable 230 cm
3	ANT_35_TR_DAB	Rigid antenna DAB+ - Round base - Extension cable 205 cm
	ANT_PB_DAB	DAB+ windscreen antenna
4	ANT_ELEC_PB	Windscreen Electronical Antenna

ANTENNAS ACCESSORIES



Item code		
1	ADAPT_ISO_COUDE_F	Right-angle Female Antenna Adaptor (ISO)
2	ADAPT_ISO_DROIT	Straight Female Antenna Adaptor (ISO) 15 cm
3	ADAPT_ISO_F	Straight antenna adaptor (ISO)
4	EL_CP1	70 cm coaxial Antenna Extension
	EL_CP2	150 cm coaxial Antenna Extension

FRAMES AND STANDS



Item code		
1	SETENJO2	Front panel radio frame 2mm
	SETENJO4	Front panel radio frame 4mm
	SETENJO10	Front panel radio frame 10mm
2	SUP_AR_120	Fixation stand for 120mm
	SUP_AR_175	Fixation stand For 175mm

CONVERTERS



Item code		
1	CC_WAE_DCDC06	WAECO voltage converter 24 Volts DC / 12 Volts DC 6 amps (nominal) / 10 amps (peak)
	CC_WAE_DCDC24	WAECO voltage converter 24 Volts DC / 12 Volts DC 18 amps (nominal) / 24 amps (peak)
2	CC_WAE_808-12	WAECO voltage converter 220 Volts AC / 12 Volts DC 8 amps
3	CC_WAE_PP152	WAECO voltage converter 12 Volts DC / 220 Volts AC

Non-exhaustive list, please contact the sales department for more information.

HARNESSES

Connect our radios to your machines thanks to our adaptor cables.



FID610

Item code : FID610



ISO 9-wire adaptor bundle for Kubota machines (old generations)



FID620

Item code : FID620



Harness for KUBOTA mini excavators : U55-4, U48-4, KX057-4, KX080



FID900

Item code : FID900



Adaptor harness (Mitsubishi/ ISO 2 loudspeakers) for Case CX construction machines



FID920

Item code : FID920



Harness for CASE CONSTRUCTION machines with a Hyundai (Asia) connector : CX18C, CX26C, CX37C.



FID CANBUS VT

Item code : FID_CANBUS_VT

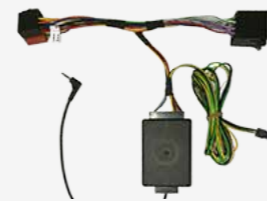

Adaptor cable between AMS radios and the Smarttouch on Valtra tractors, VERSU and DIRECT ranges : N, T and S series (with armrest controls)



VIDEO KITS, CAMERAS AND ACCESSORIES

Our video kits are developed to resist to the most demanding fields of activity : extreme weather conditions, vibrations, shocks. From the entry-level kit, up to the wireless kit or the waterproof one, our video kit range meets all your needs! All our products are guaranteed for 2 years.

VIDEO KIT INITIAL

Item code : VICAM-AMS-7P-INITIAL



The INITIAL video kit is part of the new «low spec» range INITIAL by AMS : robust and easy-to-use products at low prices.

This simplified video kit brings together all the main functions. It is equipped with the intermittency mode and 2 cameras inputs.



The 7P12V video kit is a complete and easy-to-use equipment.

Available in 7" or 9", the screen gives you a sharp and contrasted image for a better visibility. You can connect up to 2 cameras.

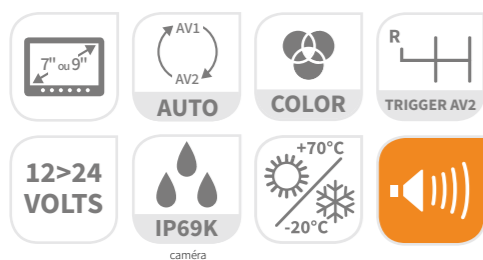

WATERPROOF VIDEO KIT

Item code : VICAM-AMS-7WP-12V



The 7P WP brings together all the features of our classic kits while being waterproof.

Take advantage of an efficient product usable in all the fields of activity.

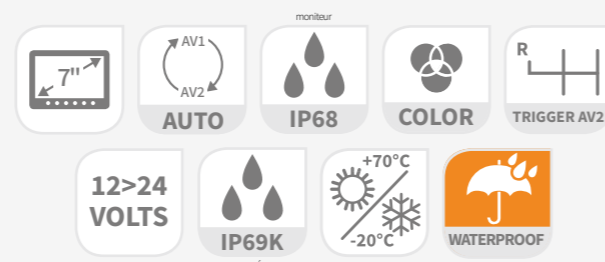

4 INPUTS VIDEO KIT

Item code : VICAM-AMS-7SP4-12V / VICAM-AMS-9SP4-12V



The video kit 7SP4-12V is a complete and easy-to-use equipment.

Available in 7" or 9", the screen offers a clear and contrasted image for optimal visibility. You can connect up to 4 cameras. Split screen mode gives you a complete view of your cameras.

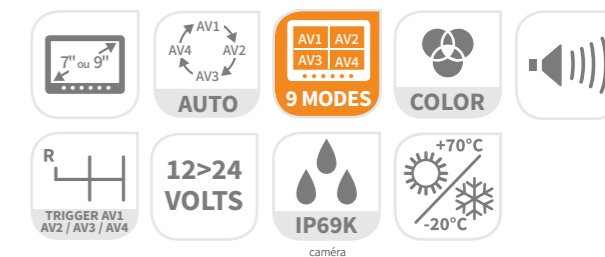

2 INPUTS VIDEO KIT

Item code : VICAM-AMS-7P-12V / VICAM-AMS-9P-12V



Enjoy the wireless technology with the 7SP4-WL kit. You can pair up to 4 cameras and see them simultaneously thanks to the split screen mode.

Maximum protection rating IP69K against dust/liquids (camera).

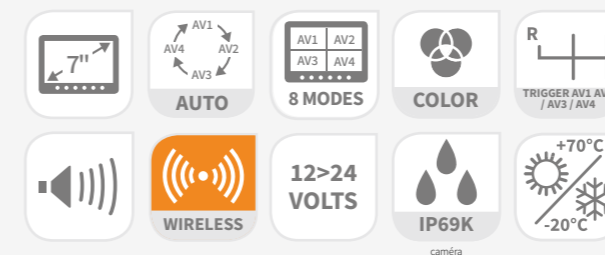

WIRELESS VIDEO KIT

Item code : VICAM-AMS-7SP4-WL



ACCESSORIES

MAGNETISED BATTERY

Item code : VICAM-AMS-POWER-PACK

The external battery is compatible with our wireless camera range. The battery is magnetised and enables a quick installation. The product is sold individually with a universal charger.



AMS cameras all have infrared night vision, which provides a better visibility. They are robust, waterproof and dustproof.

INITIAL CAMERA

Item code : VICAM-AMS-CAM-PAL-INITIAL



- IP69K
- 420 TVL
- 120°
- +70°C / -20°C
- ±15M
- PAL
- ÉCO

120° CAMERA

Item code : VICAM-AMS-CAM-PAL



- IP69K
- 700 TVL
- 120°
- +70°C / -20°C
- ±15M
- PAL
- EMA AMS

MICRO CAM

Front view : VICAM-AMS-MICRO-CAM-F
Rear View : VICAM-AMS-MICRO-CAM-R



- IP68
- 700 TVL
- 150°
- +70°C / -20°C
- PAL

MINI CAMERA

Item code : VICAM-AMS-MINI-CAM



- IP68
- 700 TVL
- 145°
- +70°C / -20°C
- PAL

WIRELESS CAMERA

Item code : VICAM-AMS-CAM-PAL-WL



- IP69K
- 600 TVL
- WIRELESS
- 120°
- +70°C / -20°C
- ±15M
- PAL

50° WIRELESS CAMERA

Item code : VICAM-AMS-CAM-PAL-WL-50



- IP69K
- 600 TVL
- WIRELESS
- 50°
- +70°C / -20°C
- ±15M
- PAL

NEW

50° CAMERA

Item code : VICAM-AMS-CAM-PAL-50D



- IP69K
- 700 TVL
- 50°
- +70°C / -20°C
- EMA AMS

NEW

SIDE CAMERA KEY

Item code : VICAM-AMS-CAM-PALB1 / VICAM-AMS-CAM-PALB2



- IP68
- 700 TVL
- 120°
- +70°C / -20°C
- ±15M
- PAL
- EMA AMS

REARVIEW CAMERA

Item code : VICAM-AMS-CAM-PALBS



- IP68
- 700 TVL
- 120°
- +70°C / -20°C
- ±15M
- PAL

DUAL OBJECTIVE CAMERA

Item code : VICAM-AMS-CAM-PALD



- IP68
- 700 TVL
- 120°
- 40°
- EMA AMS

SAFETY KIT OF 2 CAMERAS

Item code : KIT_SAFETY_CAM



Optimize your visibility for better safety with our «safety-cam».

Visibility can be reduced on agricultural machines, this is the reason why we have developed the SAFETYCAM KIT. Using two side cameras, you get optimal visibility on the road, which was impossible alone from your cabine.

The kit is composed of two CAMPAL cameras, one magnetic support, one metal support and one 10m extension cable.

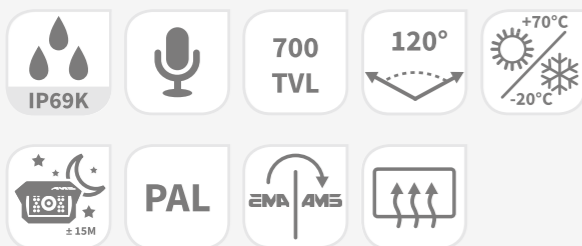

SPECIFIC CAMERAS

CASE-CX CAMERA

Item code : VICAM-AMS-CASE-CX



Mini camera adapted to the digital touch screen in the **CASE CONSTRUCTION mini excavators**. Ideal for narrow spaces, it enables a vision of 140° at the rear of the machine.

NEW



FT-1000 CAMERA

Item code : VICAM-AMS-FT-1000



The FT-1000 MICRO CAM is an integrated camera. Equipped with a 150° viewing angle, it enables an optimal front view on your **Fendt machine**. Delivered with an adaptor ring and a 5m extension cable.

NEW



NEW

4.3" SCREEN

Item code : VICAM-AMS-M4



2 video inputs - Delivered with a 10m cable

NEW

5" SCREEN

Item code : VICAM-AMS-M5WP



2 video inputs - **dustproof and waterproof**

INITIAL SCREEN

Item code : VICAM-AMS-M7-INITIAL



2 video inputs - Intermittence mode

7" OR 9" SCREEN

Item code : VICAM-AMS-M7-12V / VICAM-AMS-M9-12V



2 video inputs - Intermittence mode - **sound**

7" SCREEN

Item code : VICAM-AMS-M7WP



2 video inputs - **dustproof and waterproof**

7" OR 9" SCREEN

Item code : VICAM-AMS-MS7-12V / VICAM-AMS-MS9-12V



4 video inputs - Intermittence and split mode

7" WIRELESS SCREEN

Item code : VICAM-AMS-MS7-WL

- 4 video inputs
- Intermittence and split mode
- **Wireless**
- 8 screen modes



All our cameras and screens are guaranteed for 2 years



Vibration and dust resistant



Developed to fit the most demanding fields of application



Easy to use and efficient

SCREENS	M4	M5	M7 Initial	M7/M9	M7 WP	MS7/MS9	MS7 WL
Screen size	4.3"	5"	7"	7" ou 9"	7"	7" ou 9"	7"
Number of inputs	2 inputs	2 inputs	2 inputs	2 inputs	2 inputs	4 inputs	4 inputs
Protection rating	IP40	IP69K	IP40	IP40	IP68	IP40	IP40
Colour display	✓	✓	✓	✓	✓	✓	✓
Intermittence mode	-	-	✓	✓	✓	✓	✓
Split mode	-	-	-	-	-	✓	✓
Temperature range	+50°C -20°C	-10°C - +65°C	+70°C -20°C	+70°C -20°C	+70°C -20°C	+70°C -20°C	+70°C -20°C
Auto brightness and contrast adjustment	-	-	✓	✓	✓	✓	✓
Mirror mode	-	-	✓	✓	✓	✓	✓
Definition mode	480x272 pixels	640x480 pixels	756x504 pixels	800x480 pixels	800x480 pixels	800x480 pixels	800x480 pixels
PAL NTSC	✓	✓	✓	✓	✓	✓	✓
Sound	-	✓	-	✓	✓	✓	✓
Wireless	-	-	-	-	-	-	✓
Waterproof	-	✓	-	-	✓	-	-
Voltage	12 volts	12 volts	12>24 volts	12>24 volts	12>24 volts	12>24 volts	12>24 volts
Dimension	127,5x89,5x38,3	113x139x59	181x128x37	181x128x37	181x128x37	7" 181x128x37 9" : 234x158x38	181x128x37

CAMERAS	CAMPAL INITIAL	CAMPAL	CAMPAL WL	CAMPAL WL 50	MICRO CAM FRONT	MICRO CAM REAR
Protection rating	IP69K	IP69K	IP69K	IP69K	IP68	IP68
View angle (diagonal)	120°	120°	120°	50°	150°	150°
Temperature range	+70°C -20°C	+70°C -20°C	+70°C -20°C	+70°C -20°C	+70°C -20°C	+70°C -20°C
VGA output	756x504 pixels	976x582 pixels	756x504 pixels	756x504 pixels	976x592 pixels	976x592 pixels
Definition (TVL)	420	700	600	600	420	420
Sensor	1/3 CMOS	CCD 1/3 SONY	1/3 CMOS	1/3 CMOS	Cmos 1/4	Cmos 1/4
Micro	-	✓	✓	✓	-	-
Heating	-	✓	-	-	-	-
Night vision	✓	✓	✓	✓	-	-
Vision backlight	✓	✓	✓	✓	-	-
Wireless	-	-	✓	✓	-	-
LED IR	18	18	18	18	-	-
Voltage	12 volts	12 volts	12/24 volts	12/24 volts	12 volts	12 volts
Feature	-	-	Articulated stand Wireless camera	Articulated stand Wireless camera	Front vision	Rear vision
Dimensions	97x89x77	97x89x77	97x119x77	97x119x77	Ø 20	Ø 20

CAMERAS	MINI CAM	CAMPAL 50	CAMPAL B1	CAMPAL B1	CAMPAL BS	CAMPAL D
Protection rating	IP69K	IP69K	IP68	IP68	IP68	IP68
View angle (diagonal)	145°	50°	120°	120°	120°	120° - 40°
Temperature range	+70°C -20°C	+70°C -20°C	+70°C -20°C	+70°C -20°C	+70°C -20°C	+70°C -20°C
VGA output	976x592 pixels	976x582 pixels	976x582 pixels	976x582 pixels	976x582 pixels	976x582 pixels
Definition (TVL)	700	700	700	700	700	700
Sensor	1/3 CMOS	CCD 1/3 SONY	CCD 1/3 SONY	CCD 1/3 SONY	CCD 1/3 SONY	CCD 1/3 SONY
Micro	-	✓	-	-	-	✓
Heating	-	✓	✓	✓	✓	✓
Night vision	-	✓	✓	✓	✓	✓
Vision backlight	-	✓	✓	✓	✓	✓
Wireless	-	-	-	-	-	-
LED IR	-	18	9	9	9	15
Voltage	12 volts	12 volts	12 volts	12 volts	12 volts	12 volts
Feature	-	-	Round cameras	Round cameras	Ideal for commercial vehicle	Double objective camera
Dimensions	35,5x38,5x36,4	97x89x77	130x90x120	130x90x120	130x90x120	100x85x65

COMBINE

Driving assistance and emptying storage hopper assistance

Backup camera
(camera CAMPAL)

View on drain tube
(camera CAMPAL)

View on towing bracket
(camera CAMPAL)

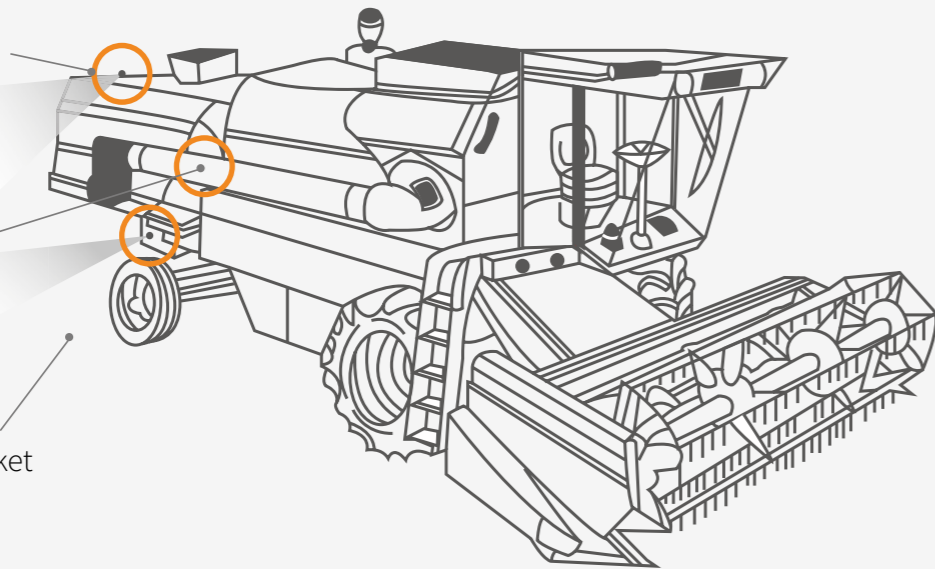

OUR PRODUCTS MEET ALL YOUR NEEDS !

AGRICULTURE, CONSTRUCTION, ROAD MAINTENANCE,
LORRIES, ETC.

WASTE TRUCK

Secure your operations

Backup camera
(camera CAMPAL)

Side view
(camera B2)

Front side view
(camera B1)

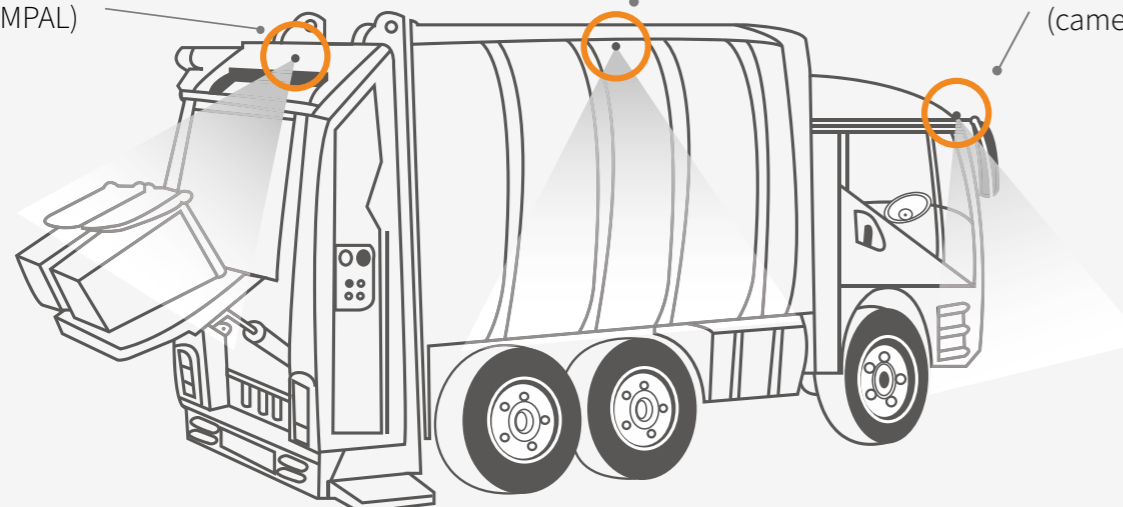

VICAM-AMS-AGL-INCOMMAND

Ag Leader

AGL INCOMMAND

The cable is suitable for the monitor AG INCOMMAND 800 or 1200. You can connect up to 4 cameras with this cable.



VICAM-AMS-AGL-INTEGRA

Ag Leader

AGL INTEGRA

This adaptor cable enables you to use a AMS camera on the monitor AG Leader INTEGRA or VERSA. You can connect up to 4 cameras with this cable.



VICAM-AMS-CASE-COMBINE
VICAM-AMS-CASE-RB
VICAM-AMS-CASE-TRACTOR

CASE II
AGRICULTURE

CASE COMBINE / CASE RB / CASE TRACTOR

This adaptor cable enables you to use a AMS camera on the monitor AFS PRO 300 or 700 for CASE-IH Axial combine (for models lesser than YDG 222 001), tractors and balers. You can connect up to 3 cameras with this cable.



VICAM-AMS-CASE-COMBINE2

CASE II
AGRICULTURE

CASE COMBINE 2

This adaptor cable enables you to use a AMS camera on the monitor AFS PRO 300 or 700 for CASE-IH Axial combine starting from model YDG 222 001. You can connect up to 3 cameras with this cable.



VICAM-AMS-CASE-TRACTOR2

CASE II
AGRICULTURE

CASE TRACTOR 2

This adaptor cable enables you to use a AMS camera on the monitor AFS700 (CASE-IH's tractors) and S-TECH (Steyr's tractor). You can connect up to 3 cameras with this cable.



VICAM-AMS-CCI1200

GRIMME **KRONE**
KUHN **RAUCH**

CCI1200

This adaptor cable enables you to use a AMS camera to CCI 1200 monitor available on GRIMME, KRONE, KUHN, RAUCH and CCI Groupe machines.

NEW



VICAM-AMS-CLAAS-S10

CLAAS

CLAAS S10

The cable is suitable for the monitor monitor S10. You can connect up to 4 cameras with this cable.



VICAM-AMS-CLAAS-PCAM1

CLAAS

CLAAS PCAM1

This adaptor cable enables you to use a AMS camera to Claas machinery with the Profi Cam system pre-installed. Up to three video inputs available on the system.



VICAM-AMS-FT-COMBINE
VICAM-AMS-FT-TRACTOR1

FENDT

FT COMBINE / FT TRACTOR1

The cable FT COMBINE is suitable for the monitor VARIOTRONIC (harvester). The cable FT TRACTOR 1 is suitable for the monitor VARIOTRONIC NT1.

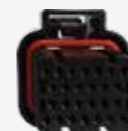

VICAM-AMS-JD-COMBINE
VICAM-AMS-JD-TRACTOR

JOHN DEERE

JD COMBINE / JD TRACTOR

This adaptor cable enables you to use a AMS camera on the monitor GREENSTAR 2630 for combine (JD COMBINE) and tractors (JD TRACTOR) John Deere. You can connect up to 3 cameras with this cable.



VICAM-AMS-JD-TRACTOR



JD TRACTOR 2

This adaptor cable enables you to use a AMS camera to John Deere's monitor on tractors from serie 6, 7, 8 or 9 (depending on equipment and option).



VICAM-AMS-JD-SILAGE-MC



JD SILAGE MC

This adaptor cable enables you to use a AMS monitor on the camera of origin for John Deere silage harvester.



VICAM-AMS-KBT-TRACTOR



KBT TRACTOR

This adaptor cable enables you to use a AMS camera on the monitor 7" and 12" K-monitor for Kubota tractors.



VICAM-AMS-LAND_DSM



LAND DSM

This adaptor cable enables you to use a AMS camera on the monitor DSM for Landini tractors.



VICAM-AMS-MER-TEL1



MER TEL 1

This adaptor cable enables you to use a AMS camera on the monitor Merlo (except 35-7). The monitor has 2 inputs.



VICAM-AMS-MF-COMBINE1



MF COMBINE

This adaptor cable enables you to use a AMS camera on the monitor Tech Touch for Massey Ferguson combines.



VICAM-AMS-MF-TRACTOR1
VICAM-AMS-MF-TRACTOR2



MF TRACTOR 1 / MF TRACTOR 2

The MF TRACTOR1 cable enables you to use a AMS camera on the monitor DATATRONIC3 for Massey Ferguson tractors.
The MF TRACTOR2 cable enables you to use a AMS camera on the monitor DATATRONIC4 and Fieldstar5 for Massey Ferguson tractors.



VICAM-AMS-MF-TRACTOR3



MF TRACTOR 3

This adaptor cable enables you to use a AMS camera on the monitor DATATRONIC5 for Massey Ferguson tractors.



VICAM-AMS-MC-DSM



MC DSM

This adaptor cable enables you to use a AMS camera on the monitor DSM for McCormick tractors.



VICAM-AMS-NHL-COMB3-MC



NHL COMB 3 MC

This adaptor cable enables you to use a AMS monitor on on the integrated camera in New Holland harvesters : CR7, CR8, CR9 and CR10 produced from serial number xx1957xxx.



VICAM-AMS-NHL-COMBINE



NHL COMBINE

This adaptor cable enables you to use a AMS camera on the monitor IntelliView II, III and IV for New Holland harvesters.



VICAM-AMS-NHL-COMBINE2
VICAM-AMS-NHL-COMBINE3



NHL COMBINE 2 / NHL COMBINE 3

The NHL COMBINE2 cable enables you to use a AMS camera on the monitor IntelliView IV for New Holland combines : CR7, CR8, CR9 and CR10 from January 2015.

The NHL COMBINE3 cable enables you to use a AMS camera on the monitor IntelliView IV for New Holland combines : CR7, CR8, CR9 and CR10 produced from serial number xx1957xxx.



VICAM-AMS-NHL-COMBINE4



NHL COMBINE 4

This adaptor cable enables you to use a AMS camera on the monitor IntelliView IV for New Holland combines : CX5 and 6TIER 4B - CX7 and 8TIER 4B - CR7, 8, 9 and 10 REVELATION



VICAM-AMS-NHL-RB1
VICAM-AMS-NHL-TRACTOR
VICAM-AMS-STEYR-TRACTOR



NHL RB1 / NHL TRACTOR / STEYR TRACTOR

The cables NHL are suitable for tractor or baler NEW HOLLAND.
The cable STEYR is suitable for the monitor S-TECH. You can connect up to 3 cameras with this cable.



VICAM-AMS-NHL-TRACTOR2



NHL TRACTOR 2

This adaptor cable enables you to use a AMS camera on the monitor IntelliView IV for New Holland tractors : T6 HD, T7 HD. You can connect up to 3 cameras with this cable.



VICAM-AMS-S-DIN-F

S-DIN F

This adaptor cable enables you to connect an AMS monitor to a camera with male S-DIN connector with screws



VICAM-AMS-TRIMB



TRIMB

This adaptor cable enables you to use a AMS camera on the monitor CFX 750 (FM 750), FMX (FM1000), GFX750 (XCN-1050) and TMX-2050 (XCN-2050).



VICAM-AMS-TRIMB2



TRIMB2

This adaptor cable enables you to use a AMS camera on the monitor TMX-2050 (XCN-2050).



VICAM-AMS-VT-TRACTOR1



VT TRACTOR 1

This adaptor cable enables you to use a AMS camera on the monitor Smart Touch for Valtra machines.

CÂBLES ET ACCESSOIRES



Références

1	VICAM-AMS-CR2	Camera extension cable 4 pin 2 meters
	VICAM-AMS-CR5	Camera extension cable 4 pin 5 meters
	VICAM-AMS-CR10	Camera extension cable 4 pin 10 meters
	VICAM-AMS-CR15	Camera extension cable 4 pin 15 metres
	VICAM-AMS-CR20	Camera extension cable 4 pin 20 metres
2	VICAM-AMS-CR10-2W	10 m extension cable to connect 2 cameras - 4 pin
3	VICAM-AMS-CSP10	Extension cable spiral shaped - 10m (without sound on the monitor)
	VICAM-AMS-CSP2	Extension cable spiral shaped - 2m (without sound on the monitor)
4	VICAM-AMS-PM	Articulated stand for monitor and resistant to vibrations, compatible 7 and 9"
5	VICAM-AMS-PM7	Articulated video stand Screen 7" : 57 mm (before 2014)
	VICAM-AMS-PM9	Articulated video stand Screen 9" : 87 mm (before 2014)
6	VICAM-AMS-SUPMAGNET	Magnetic support to position 1 camera without any tool
7	VICAM-AMS-SUPINTER	Square support for 2 cameras
8	VICAM-AMS-PC2	Mounting bracket and CAMPAL camera cap + screws (from April 2015)
9	VICAM-AMS-CP	Camera cover for CAMP-PAL/CAM-B1-2 (dimension 130*105*80 mm)
10	VICAM-AMS-SP4	Splitted screen system for 4 inputs screen
11	VICAM-CAP-CR	Protective cap for extension cables (x3)
12	VICAM-AMS-ANT-WL	Remote antenna for wireless range
13	VICAM-AMS-RX-TX	Upgrade your wired monitors and cameras with our modules onto wireless technology
14	VICAM-AMS-SUPMON-INTEL	Monitor mounting bracket for Intelliview 3-4

See our website for the complete range of accessories

#4 AMS DISPLAYER

DISPLAYER

Discover the AMS displayer that can be adjusted according to your needs. Play with the forms and use as many cubes as needed, assembling them around the power supply cube.

Video box, radio box, or both ! Choose the right layout for your shop.

A DISPLAY TO YOUR NEEDS



1 CUBE = 1 FUNCTION

- Modern cube with front in stainless steel
- Base model : 5 cubes
- Available cubes : Power supply, Loudspeaker, Radio, Video kit, Camera or Empty cube
- Products are not included



RADIO CUBE



- 1 radio slot
- Antenna + exterior antenna input
- Backlit AMS logo

LOUDSPEAKER CUBE



- 1 Loudspeaker (HP-100-BC)
- 1 grid (HP-GR-100)
- Backlit AMS logo

VIDEO KIT CUBE



- 1 monitor and camera slot
- Backlit AMS logo

CAMERA CUBE

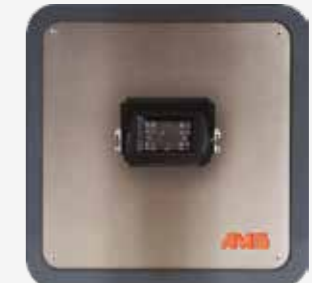

- 1 AMS camera slot
- Backlit AMS logo

POWER SUPPLY CUBE



- Backlit AMS logo
- Multiple outputs

EMPTY CUBE

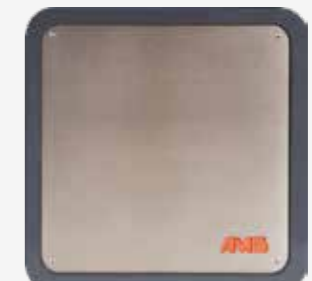

- Backlit AMS logo
- Possibility to add a sticker with your brand logo

AMS

SAFETY & COMFORT

Rue des Galeries - Z.A du Chevalement
59286 ROOST WARENDIN - France
☎ +33 (0)3 27 94 44 44 📠 +33 (0)3 27 94 44 45
✉ contact@ams-diffusion.com



www.ams-diffusion.com